

REAR PANEL

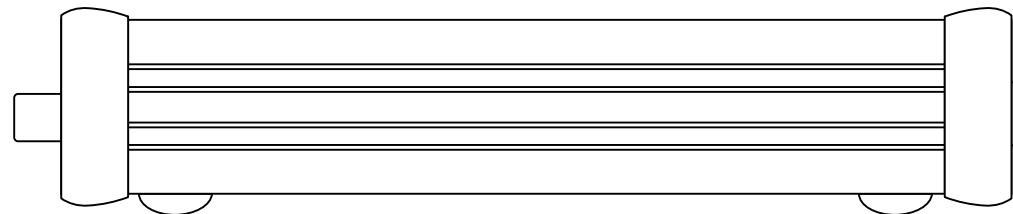

KG4JJH				
TITLE PHASER ASSEMBLY				
DESIGN DJ5IL	DRAWN AWB	SCALE 1:1	SHEET 1 OF 2	REV 0

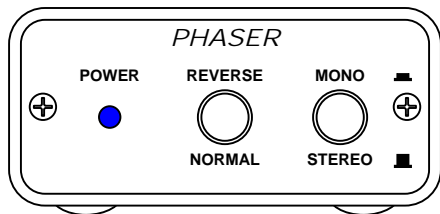
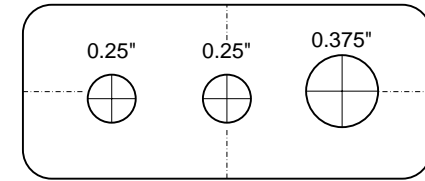
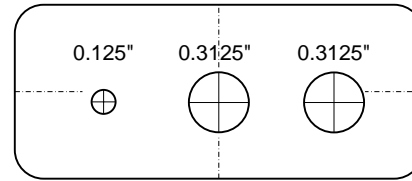
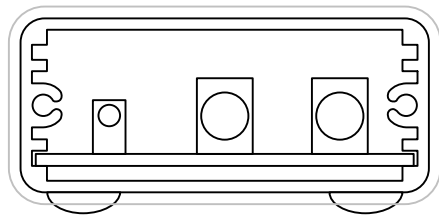
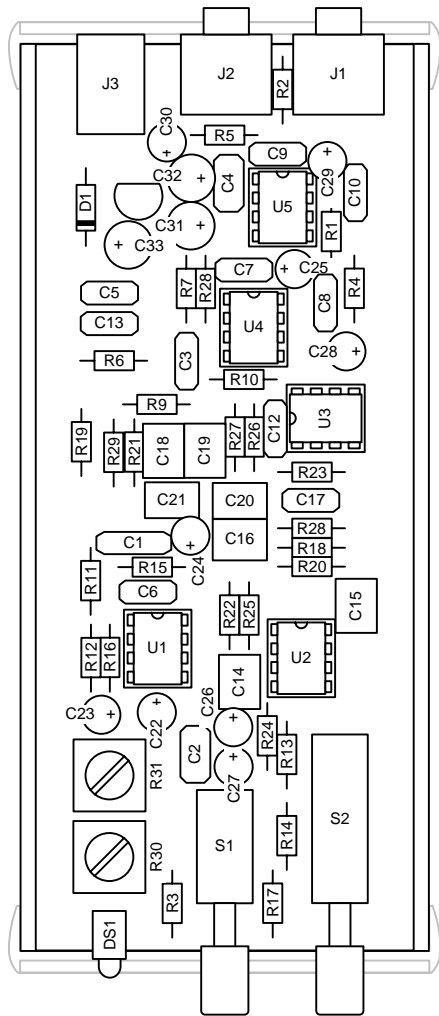

DRILL TEMPLATES

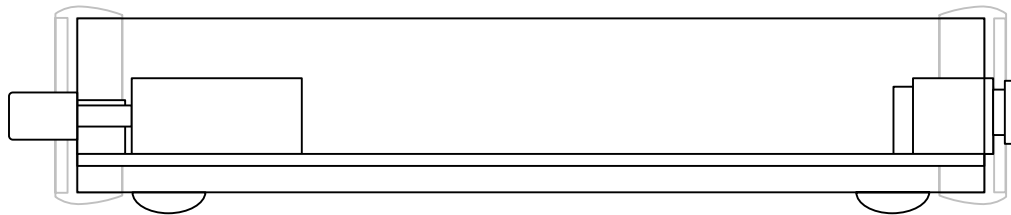

KG4JJH			
TITLE PHASER			
PC BOARD DETAILS			
DESIGN DJ5IL	DRAWN AWB	SCALE 1:1	SHEET 2 OF 2 REV 0